



## User Manual

# SMART BATTERY CHARGER

Model: SHARK CI-4000

AC Input: 220-240VAC, 50-60Hz, 75W

DC Output: 12VDC, 2A/4A or 6VDC, 2A

Temperature Controlled





## DANGER



Please read and understand all important safety warnings and operating instructions before using this charger. In addition, please read and follow all battery and vehicle manufacturer's instructions and cautionary labels. Failure to follow the instructions may result in **ELECTRICAL SHOCK, EXPLOSION, or FIRE**, which may result in **SERIOUS INJURY, DEATH, DAMAGE TO DEVICE or PROPERTY**

This manual contains important information on the safe operation of this product. Your satisfaction with this SHARK charger and its safe operation is our ultimate concern. Therefore please take the time to read the entire manual, especially the Safety Precautions. They will help you to avoid potential hazards that may exist when working with this product.

Keep this User's Manual for future reference.

Copyright © 2023 ASP Group Distributing

No part of this manual may be reproduced in whole or in part without written permission of the copyrights holder.

The Supplier is not liable to any party for loss or damage caused by any error or omission in this manual, whether such error results from negligence, accident, or any other cause.

## What's Included

- SHARK CI-4000 Battery Charger
- Battery Clamp Connectors
- Fuse (Extra) & Screws
- User Manual



### **RISK OF EXPLOSIVE GASES**

WORKING IN THE VICINITY OF A LEAD-ACID BATTERY IS DANGEROUS. BATTERIES GENERATE EXPLOSIVE GASES DURING NORMAL BATTERY OPERATION. FOR THIS REASON, IT IS OF UTMOST IMPORTANCE THAT YOU FOLLOW THE INSTRUCTIONS EACH TIME YOU USE THE CHARGER.

To reduce risk of battery explosion, follow these instructions and instructions published by battery manufacturer and manufacturer of any equipment intended to be used in vicinity of battery. Review cautionary labels on these products and on the engine.

## **SAFETY PRECAUTIONS FOR WORKING IN THE VICINITY OF LEAD ACID BATTERIES:**

- 1) Batteries generate explosive gases during normal operation. Use in well-ventilated area.
- 2) Consider having someone close enough or within the range of your voice to come to your aid when you work near a lead-acid battery.
- 3) **DO NOT** smoke, strike a match, or cause a spark in vicinity of battery or engine. Avoid explosive gas, flames and sparks.
- 4) Remove all personal jewelry, such as rings, bracelets, necklaces, and watches when working with a lead-acid battery. These items may create a short-circuit that may cause severe burns.
- 5) Be extra cautious to reduce risk of dropping a metal tool onto the battery. It might spark or short-circuit a battery or other electrical hardware which may cause an explosion or fire.
- 6) Wear complete eye protection, and hand and clothing protection. Avoid touching eyes while working near a battery.
- 7) Study all battery manufacturer's specific precautions such as removing or not removing cell caps when charging and

recommended rates of charge.

- 8) Clean battery terminals before connecting the charger. Be careful to keep corrosion from coming into contact with eyes.
- 9) For battery installed in a vehicle, first connect the positive (red) charger clamp to positive (+) terminal on the battery. Second, connect the negative charger clamp (black) to the vehicle's chassis (away from the battery). **DO NOT** connect to the carburetor or fuel lines. Disconnect the negative clamp (black) from the vehicle chassis first.
- 10) When it is necessary to remove a battery from vehicle to charge, always remove grounded terminal from battery first. Make sure all accessories in the vehicle are switched off in order to prevent an arc.
- 11) It is not intended to supply power to an extra-low-voltage electrical systems or to charge dry-cell batteries. Charging dry-cell batteries may result in burst and cause injury to persons and damage to property.
- 12) **NEVER** charge a frozen, damaged, leaking or non-rechargeable battery.
- 13) If battery electrolyte contacts skin or clothing, wash it immediately with soap and water. If electrolyte enters eye, immediately flood eye with running clean cold water for at least 15 minutes and get medical attention immediately. If electrolyte is swallowed, drink large quantities of water or milk; do **NOT** induce vomiting and get prompt medical attention. Neutralize with baking soda any electrolyte that spills on a vehicle or in the work area; after neutralizing, rinse contaminated area clean with water.

## **SAFETY PRECAUTIONS FOR USING THE CHARGER**

- 1) **DO NOT** place the charger in the engine compartment or near moving parts or near the battery; place it as far away from them as DC cables permit. Never place a charger directly above a battery being charged; gases or fluids from battery will corrode and damage battery charger.
- 2) Do **NOT** cover the charger while charging.
- 3) **DO NOT** expose the charger to rain or wet conditions.

- 4) Connect and disconnect the clamps only after unplugging the charger from the electric outlet.
- 5) The use of any attachment not recommended or sold by the manufacturer may result in a risk of fire, electric shock or injury to persons.
- 6) **DO NOT** overcharge batteries by selecting the wrong charge mode.
- 7) To reduce the risk of damage to electric plug and cord, pull by the plug rather than the cord when disconnecting the charger.
- 8) To reduce risk of electric shock, unplug charger from outlet before attempting any maintenance or cleaning.
- 9) Operate with caution if the charger has received direct hit of force or have been dropped. Have it checked and repaired if damaged.
- 10) Any repairs must be carried out by the manufacturer or an authorized service in order to avoid danger.
- 11) Using of an extension cable is not recommended. If extension cable must be used, make sure that:
  - Pins on plug of extension cable must be the same number, size, and shape as those of plug on charger.
  - Ensure that the extension cord is properly wired and in good electrical condition.
  - Wire size must be large enough for the AC ampere rating of charger, as specified:
    - Up to 15 m** in length: use **10 A** extension cable.
    - 15 to 30 m** in length: use **13 A** extension cable.
    - 30 to 45 m** in length: use **14 A** extension cable.

## ABOUT THE CI-4000

1. The CI-4000 charger is designed for charging of all types of 12V/6V lead-acid, and 12V lithium-ion batteries (LIFEPO4).
2. Built-in intelligent microprocessor makes charging faster, easier and safer.
3. This charger has safety features, including anti-spark protection, protection for reverse polarity, short circuit, overcurrent, overcharge and overheat protection.
4. When starting, battery voltage is set to 12V by default. The user can select battery voltage by pressing “6V/12V” button in Standby mode.
5. When the charger is powered on, it enters the standby mode by default. The user can select functions including STD, AGM, CAL, LIFEPO4, or REPAIR by pressing “FUNCTION” button.
6. When charging starts, the current rate can be selected through the “BAT.RATE” button.

## TECHNICAL SPECIFICATIONS

AC Input	220-240 V AC, 50-60 Hz,75 W
DC Output	12V DC, 2A/4A or 6VDC, 2A Temperature Controlled.
Efficiency	85% Approximately
Charger Type	8 step, Fully automatic charging cycle
Battery Type	All types of 6V and 12V Lead-acid batteries, 12V lithium-ion batteries (LIFEPO4)
Protection Category	IP65 (splash and dust proof)
Accessories Included	Battery Clamps
Operating Temperature	0°C – 40°C

# LCD DISPLAY

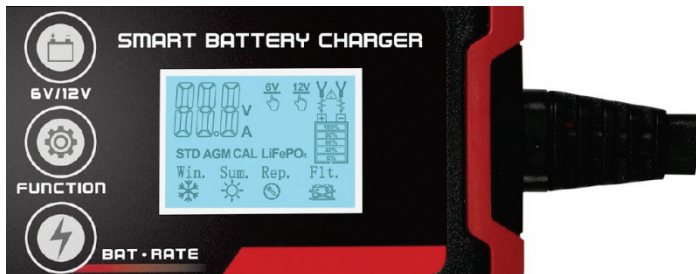
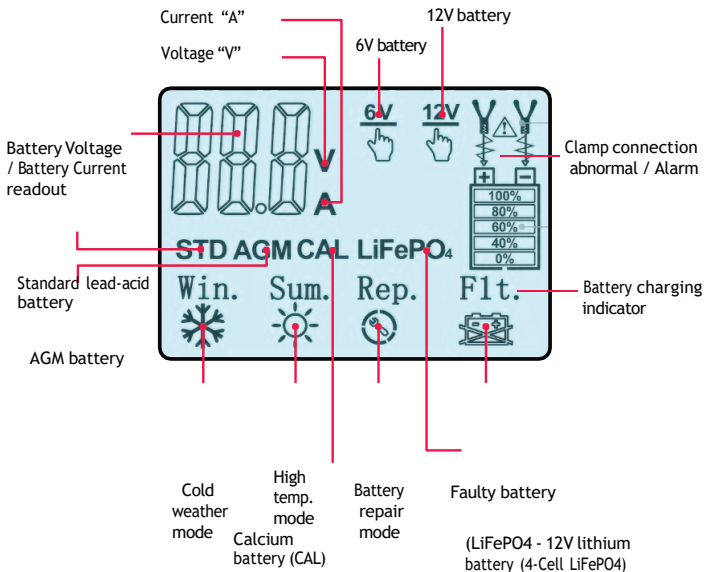

## **CONNECTING TO THE BATTERY WHEN THE BATTERY IS IN THE VEHICLE**

- 1) Plug the charger into a 230V AC outlet. Connect the charger outlet cord plug to the cord plug of the clamp connectors, or ring connectors.
- 2) Identify polarity of battery terminals. The positive battery terminal is typically marked by these letters or "+" Symbol (POS,P,+). The negative battery terminal is typically marked by these letters or "-" Symbol (NEG,N,-). Do not connect to the carburetor, fuel lines, or thin metal parts.
- 3) Identify if you have a negative or positive grounded vehicle. This can be done by identifying which battery terminal (NEGATIVE OR POSITIVE) is connected to the chassis.
- 4) For a negative grounded vehicle (most common): connect the RED POSITIVE clamp/ ring connector first to the positive battery terminal, then connect the BLACK NEGATIVE clamp / ring connector to the negative battery terminal or vehicle chassis.
- 5) For a positive grounded vehicle (very uncommon): connect the BLACK NEGATIVE clamp/ring connector first to the negative battery terminal, then connect the RED POSITIVE clamp/ring connector to the positive battery terminal or vehicle chassis.
- 6) When disconnecting, disconnect in the reverse sequence, removing the negative first (or positive first for positive ground systems).
- 7) Marine (boat) battery must be removed and charged onshore. Charging battery on-board requires equipment specially designed for marine use.







## **CONNECTING TO THE BATTERY WHEN THE BATTERY IS OUTSIDE OF THE VEHICLE**

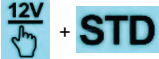

- 1) Check polarity of battery terminals. POSITIVE (POS, P, +) battery terminals usually have a larger diameter than the NEGATIVE (NEG, N, -) terminals.
- 2) Connect the RED POSITIVE cable clamp or ring terminal to the POSITIVE terminal of the battery.
- 3) Position yourself as far away from the battery as possible – then connect the BLACK NEGATIVE charger cable clamp or ring terminal to NEGATIVE post of battery.
- 4) Connect charger AC cord to the 230V electric outlet.
- 5) When disconnecting charger, always do so in reverse sequence of connecting procedure and break first connection while standing as far away from the battery as possible.
- 6) Do not face battery when making final connection.
- 7) Marine (boat) battery must be removed and charged onshore. Charging battery on-board requires equipment specially designed for marine use.

## CHARGING MODES

CI-4000 charger has 9 operational modes: Standby, 12V STD, 12V AGM, 12V CAL, 12V LITHIUM (LiFePO<sub>4</sub>), 6V STD, 6V AGM, 6V CAL, 12V-REPAIR. Do not operate the charger

until you confirm the appropriate charge mode for your battery. **CAUTION:** If you choose 12V Mode for 6V battery, the battery will be damaged!

Mode	Battery Capacity (Ah)	Note
Standby	—	Not charging or providing any power. Please check the remaining battery capacity (State of Charge)
 12V STD	2 – 120	Charging 12V STD batteries.
 12V COLD/AGM	2 – 120	Charging 12V batteries below 10°C or 12V AGM battery.
 12V CAL	2 – 120	Charging 12V CAL batteries.
 12V LITHIUM	2 – 120	Charging 12V Lithium-ion (LiFePO <sub>4</sub> ) batteries only.
 12V REPAIR	2 – 120	An advanced battery recovery mode for repairing old, idle, stratified or sulfated 12V batteries.



 + <b>STD</b> 6V COLD/AGM	2 - 120	Charging 6V STD batteries.
 + <b>AGM</b> 6V COLD/AGM	2 - 120	Charging 6V batteries below 10°C or 6V AGM battery.
 + <b>CAL</b> 6V STD	2 - 120	Charging 6V CAL batteries.

**The following modes are advanced charging modes that require your full attention before selecting.**

**12V LITHIUM** – This mode is only for 12V lithium-ion (LiFePO4) batteries. Some lithium-ion batteries may be unstable and unsuitable for charging. Consult the lithium battery manufacturer before charging and ask for recommended charging voltage and current.

**REPAIR (12V Only)** This mode is for LEAD-ACID batteries only. It is an advanced battery recovery mode for repairing old, idle, stratified or sulfated batteries. NOT all batteries can be recovered. For optimal results, take the battery through a full charge cycle, bringing the battery to full charge, before using this mode. One REPAIR cycle can take up to **eight (8) hours** to complete the recovery process and charger will enter to Standby mode when completed. This mode uses a high charging voltage and may cause some water loss in WET cell batteries. Plus, some batteries and electronics may be sensitive to high charging voltages. To minimize risks, disconnect the battery from the vehicle before using this mode.

## CHARGING MODES (CONTINUED)

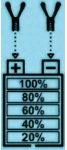
LCD DISPLAY	Note
	If the ambient temperature is lower than 0° C, the charger will enter the Cold Weather charging mode automatically.
	If the ambient temperature is higher than 30° C, the charger will automatically enter the high temperature charging mode. If the charging temperature is too high, the charger will also automatically enter the high temperature charging mode.
	The charger is in Repair mode.
	The charger is in Charging mode or Maintenance mode after the battery charge reaches 100%.

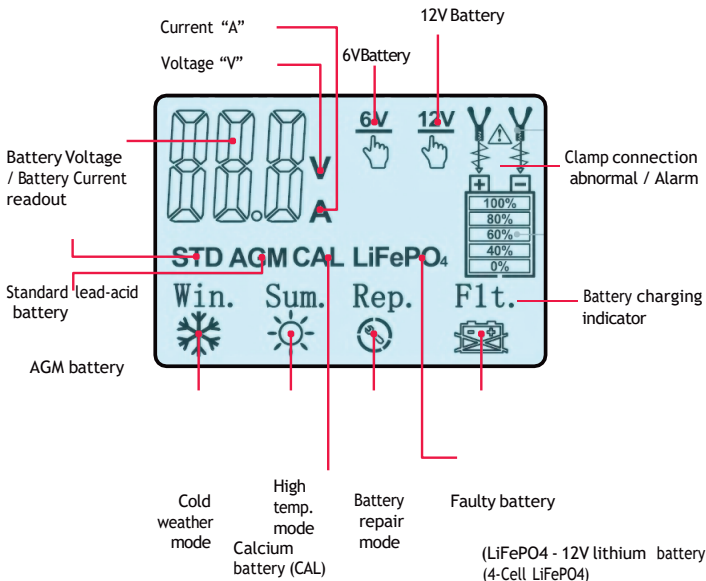

## CHARGING STEPS

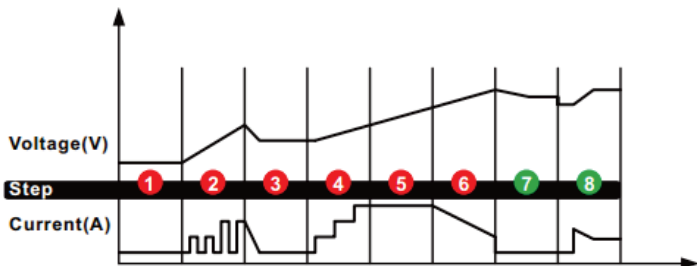

During the charging process, the charger performs following operations:

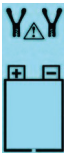

- STEP 1: DIAGNOSIS** Checks if battery has connection with the charger and also checks battery voltage.
- STEP 2: DESULFATION** (if needed) If battery voltage is too low, charger automatically generates pulsing current for **up to 10 minutes** to remove sulfate deposits.
- STEP 3: ANALYZE** (if needed) Checks if the battery voltage reaches minimum charging limit after desulfation; charging begins if the battery voltage is sufficient.
- STEP 4: SOFT START** Charges with step-ups of constant current.
- STEP 5: BULK CHARGE** Charges with constant maximum current until battery voltage reaches charging limit.
- STEP 6: ABSORPTION** Continues to charge with gradually decreasing current until battery is at 100% charge.
- STEP 7: VALIDATION** Tests if the battery can hold the charge.
- STEP 8: MAINTENANCE** Continuously monitors the battery, and intelligently adapts charging current to the variable battery voltage.

## TROUBLESHOOTING

LCD DISPLAY	CAUSE	SOLUTION
E01	Charger is overheated	Charging will automatically pause. Do NOT cut off the power supply, the charger will resume after cooling down.
EO2 + 	1) Open-circuit 2) Dirty battery terminals 3) Dead Battery 4) Output Short Circuit	1) Connect the red and black clamps to the battery terminals 2) Clean battery terminals 3) Replace the battery with a new one immediately 4) Disconnect red and black clamps

<p><b>E03</b> +</p> 	<p>Charging in 6V Mode(s) for 12V Battery</p>	<p>Restart the charger and choose the correct charging voltage.</p>
<p><b>E04</b> +</p> 	<p>Battery cannot store electric energy or cannot be recovered in Repair Mode</p>	<p>1) Replace the battery with the new one 2) If REPAIR Mode has not be tried, try it for recovery</p>
<p><b>E05</b> +</p> 	<p>Reverse polarity</p>	<p>Exchange the red and black clamps to the correct battery terminals</p>

**NOTE: Following situation indicates that battery needs to be replaced, although there is no abnormal result from LED communication.**

After full charging and with 100% on battery charging indicator, use this battery to start your vehicle's engine. If engine cannot be started (except for the problem of the vehicle itself), the battery may no longer have enough electrical storage capacity. Take your battery for evaluation to a battery service workshop.

# SHARK PROFESSIONAL ACCESSORIES LIMITED WARRANTY

## Repair/Replacement Warranty

SHARK PROFESSIONAL ACCESSORIES warrants to the original purchaser that the mechanical and electrical components will be free of defects in material and workmanship for a period of two (2) years from the original date of purchase. This product is intended for household use only. Transportation charges on product submitted for repair or replacement under this warranty are the sole responsibility of the purchaser. This workmanship for a period of warranty only applies to the original purchaser and is not transferable. Do not return the unit to the place of purchase. If the problem persists, SHARK PROFESSIONAL ACCESSORIES will, at its option, authorize evaluation, repair or replacement of the defective part or component at a SHARK PROFESSIONAL ACCESSORIES Service Center. Repairs or replacements without prior authorization, or at an unauthorized repair workshop, will not be covered.

## Warranty Exclusions

This warranty does not cover the following repairs and equipment:

### Normal Wear

This warranty does not cover repair when normal use has exhausted the life of a part or the equipment as a whole.

### Improper Installation and Use

This warranty will not apply to parts and/or labor if this product is deemed to have been misused, neglected, involved in an accident, abused, modified, installed improperly or connected incorrectly to any electrical component.

### Other Exclusions

- Product sold as reconditioned, used as rental equipment or floor/display models sold without packaging and/or missing parts or components.
- Repair and transportation costs of Product determined not to be defective.
- Cosmetic defects such as paint, decals, etc.



## SHARK PROFESSIONAL ACCESSORIES LIMITED WARRANTY

(continued)

- Failures due to acts of God and other forces of nature beyond the manufacturer's control.
- Problems caused by parts that are not original parts.

### **Limits of Implied Warranty and Consequential Damage**

SHARK PROFESSIONAL ACCESSORIES disclaims any obligation to cover any loss of time, use of this product, freight, or any incidental or consequential claim by anyone from using this product. **THIS WARRANTY IS IN LIEU OF ALL OTHER WARRANTIES, EXPRESS OR IMPLIED, INCLUDING WARRANTIES OF MERCHANTABILITY OR FITNESS FOR A PARTICULAR PURPOSE.**

A unit provided as an exchange will be subject to the warranty of the original unit. The length of the warranty governing the exchanged unit will remain calculated by reference to the purchase date of the original unit. This warranty gives you certain legal rights which may change from country to country. Your country may also have other rights you may be entitled to, that are not listed in this warranty. Some countries do not allow the exclusions, so it may not apply to you.



Official Distributor:

ASP Group s.r.o.

Address:

Staropltzenecka 290, 326 00 Letkov  
Czech Republic

E-mail: [info@aspgroup.cz](mailto:info@aspgroup.cz)

Tel.: +420 378 21 21 21

[www.aspgroup.eu](http://www.aspgroup.eu)

**[www.shark-accessories.eu](http://www.shark-accessories.eu)**